







Seite Page	Ident-Nr. Ident-No N° d'ident	Bezeichnung Inhaltsangabe	Designation Désignation
34/2	75 6315	CP-A (FM626N4)	PCB.
34/2	78 2326	CP-A (FM626Q4 /K4)	PCB.
34/2	75 6277	CP-A (FM626W4)	PCB.
34/2-34/4	-	VD-A	PCB.
34/5-34/7	-	AD-A	PCB.
34/8	-	PW-A	PCB.
34/9	-	TN-A	PCB.
34/9	-	TM-A	PCB.
34/9	-	CV-A	PCB.
34/10	75 6015	CP-2	PCB.
34/10-34/11	-	SY-B	PCB.
34/12-34/13	-	SV-B	PCB.
34/14	-	TM-B	PCB.
34/15	75 6278	VD-1 (FM626Q4/K4 /N4)	PCB.
34/15	75 6031	VD-1 (FM626W4)	PCB.
34/16	75 6018	VD-2	PCB.
34/17	75 6019	VP-1	PCB.
34/18	75 6022	AD-1	PCB.
34/19-34/20	75 6023	PW-1	PCB.
34/21	75 6024	PW-2	PCB.
34/22	75 6276	MPX-Decoder	PCB.
34/23-34/24	75 6014	TM-1	PCB.
34/25	75 6020	TM-2 (FM626Q4/W4)	PCB.
34/25	75 6313	TM-2 (FM626K4/N4)	PCB.
34/25	75 6021	TM-3	PCB.
34/25	75 6314	TN-5 (FM626N4/FZ150G4)	PCB.
34/26-34/27	75 6030	TM-6 (FM626W4/FZ130G4)	PCB.
34/28	75 6260	TM-7	PCB.
34/28	75 6016	TB-1	PCB.
34/29-34/32		Explosionszeichnungen	exploded view
34/33	75 6027	Fernbedienung	remote control
34/34		Bedienungsanleitung - Service-Anleitungen	telecommande instruction manual instruction d'emploi

SIEMENS

FM626K4
FM626Q4
FM626W4
FM626N4

VIDEOGERÄTE
VIDEO-CASS-RECORDER
Video Equipments
Video Cartridge Recorder
Equipments Video
Enregistreur Cassette Video



Pos. Item Pos.	Ident-Nr. Ident-No N° d'ident	Bezeichnung	Designation Désignation
CP-A CP-A CP-A VD-A	75 6315 78 2326 75 6277 -	CHASSIS FM626N4 CHASSIS FM626Q4/K4 CHASSIS FM626W4 VIDEO (CP-A)	P.C.B. P.C.B. P.C.B.
D1001	73 1459	 GMA01-BT (1SS133-T-77)	
D1002	73 1459	GMA01-BT (1SS133-T-77)	
D1003	73 1459	GMA01-BT (1SS133-T-77)	
D1004	73 1459	GMA01-BT (1SS133-T-77)	
D1005	73 3992	Zener GZS9.1Y-TB (Zener MTZ9.1C-T-77)	
D1007	73 1459	GMA01-BT (1SS133-T-77)	
D1008	73 4586	Zener GZS5.6Y-BT (Zener MTZ5.6BT-77)	
D1092	73 1459	GMA01-BT (1SS133-T-77)	
D1251	73 1459	GMA01-BT (1SS133-T-77)	
D1254	73 1459	GMA01-BT (1SS133-T-77)	
IC101 IC102 IC103 IC121	73 6381 73 4554 73 6382 73 0303	 LA7340 MSM6965-3RS LA7330 BA7025L	

Pos. Item Pos.	Ident-Nr. Ident-No N° d'ident	Bezeichnung	Designation Désignation
			
B3001	73 1476	2SC3402-AC	
B3201	73 2424	2SC3399-AC	
B3202	73 1476	(DTC144ES-DCTP)	
B3203	73 1476	2SC3402-AC	
B3301	73 1476	(DTC114ES-DCTP)	
Q3001	72 2408	2SC3402-AC	
Q3002	73 2436	(DTC114ES-DCTP)	
Q3003	72 2408	2SC1740S-CDTP-R	
Q3201	72 2408	(2SC536-F-SPA-AC)	
Q3302	71 3088	2SC2839-F-SPA-AC	
		2SC536-F-SPA-AC	
		(2SC1740S-DCTP-R)	
		2SC1740S-DCTP-R	
		2SD545-F-NP-AA	
			
XF301	73 4000	4MHz	
			
R3001	73 4521	3,3 Ohm 1/2W	
R3304	72 4706	5.6 Ohm 1/4W	
RB301	73 6923	Resistor Pack 4.7x4	
			
C3015	73 7442	0.047F 5,5V (0.1F 5,5V)	

SIEMENS

FM626K4
FM626Q4
FM626W4
FM626N4



VIDEOGERÄTE
VIDEO-CASS-RECORDER
Video Equipments
Video Cartride Recorder
Equipments Video
Enregistreur Cassette Video



Pos. Item Pos.	Ident-Nr. Ident-No N° d'ident	Bezeichnung	Designation Désignation
SV-B	-	SERVO (CP-2) 	
D3501	73 1459	GMA01-BT (1SS133-T-77)	
D3502	73 1459	GMA01-BT (1SS133-T-77)	
D3503	73 1459	GMA01-BT (1SS133-T-77)	
D3504	73 1459	GMA01-BT (1SS133-T-77)	
D3506	73 1459	GMA01-BT (1SS133-T-77)	
D3509	73 1459	GMA01-BT (1SS133-T-77)	
D3516	73 1459	1SS133-T-77 (GMA01-BT)	
D3530	73 1459	1SS133-T-77 (GMA01-BT)	
D3534	73 1459	1SS133-T77 (GMA01-BT)	
D3535	73 1459	1SS133-T-77 (GMA01-BT)	
D3536	73 1459	1SS133-T-77 (GMA01-BT)	
D3537	73 1459	1SS133-T-77 (GMA01-BT)	
D3538	73 1459	1SS133-T-77 (GMA01-BT)	
D3539	73 1459	1SS133-T-77 (GMA01-BT)	
D3540	73 1459	1SS133-T-77 (GMA01-BT)	
D3541	73 1459	1SS133-T-77 (GMA01-BT)	
IC351 IC352	73 6645 73 5320	 LC7418-8085 LA7122S (LA7124)	

SIEMENS

FM626K4
FM626Q4
FM626W4
FM626N4

VIDEOGERÄTE
VIDEO-CASS-RECORDER
Video Equipments
Video Cartridge Recorder
Equipments Video
Enregistreur Cassette Video

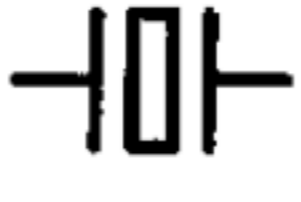

Pos. Item Pos.	Ident-Nr. Ident-No N° d'ident	Bezeichnung	Designation Désignation
			
B3501	73 2424	2SC3399	
B3502	73 2424	2SC3399	
D3503	73 2424	2SC3399	
D3504	73 2424	2SC3399	
D3505	73 2424	2SC3399	
B3506	73 2424	2SC3399	
B3507	73 2424	2SC3399	
B3508	73 2424	2SC3399	
B3509	73 2424	2SC3399	
B3510	73 2424	2SC3399	
B3511	73 2424	2SC3399	
B3512	73 2424	2SC3399	
B3513	73 2424	2SC3399	
B3514	73 2424	2SC3399	
Q3501	72 8315	2SC536	
Q3502	72 2335	2SD734	
Q3503	72 8315	2SC536	
Q3504	72 8315	2SC536	
Q3505	72 8315	2SC536	
			
VR353	73 4981	200 KOhm	
VR358	73 5334	100 KOhm (Rotary)	

Pos. Item Pos.	Ident-Nr. Ident-No N° d'ident	Bezeichnung	Designation Désignation
TM-B	-	TIMERPLATINE (CP-2) (IR-DECODER)	TIMER P.C.B.
D7401	73 1459	 1SS133	
IC741	73 5868	 LC6527H-3913	
Q7401 Q7402	73 4572 73 4572	 2SC4038Q 2SC4038Q	
XF741	73 4000	 4 MHz	

SIEMENS

FM626K4
FM626Q4
FM626W4
FM626N4



VIDEOGERÄTE
VIDEO-CASS-RECORDER
Video Equipments
Video Cartride Recorder
Equipments Video
Enregistreur Cassette Video



Pos. Item Pos.	Ident-Nr. Ident-No N° d'ident	Bezeichnung	Designation Désignation
VD-1 VD-1	75 6278 75 6031	Videoplatine FM626Q4/K4/N4 Videoplatine FM626W4	P.C.B.
D1601	73 1459	 1SS133-T-77 (GMA01-BT)	
D1602	73 1459	1SS133-T-77 (GMA01-BT)	
D1603	73 1459	1SS133-T-77 (GMA01-BT)	
D1604	73 1459	1SS133-T-77 (GMA01-BT)	
D1605	73 1459	1SS133-T-77 (GMA01-BT)	
D1606	73 1459	1SS133-T-77 (GMA01-BT)	
IC162 IC163 IC164	73 6417 73 6946 73 6945	 BA7605N NJM2246L NJM2235L	
B1602	73 2424	 2SC3399-AC	
Q1604	72 1470	2SA608-E-SPA-AC (2SA933S-TP-Q)	
Q1607	72 1470	2SA608-E-SPA-AC (2SA933S-TP-Q)	
Q1608	72 1470	2SA608-E-SPA-AC (2SA933S-TP-Q)	





SIEMENS

FM626K4
FM626Q4
FM626W4
FM626N4

VIDEOGERÄTE
VIDEO-CASS-RECORDER
Video Equipments
Video Cartridge Recorder
Equipments Video
Enregistreur Cassette Video

Pos. Item Pos.	Ident-Nr. Ident-No N° d'ident	Bezeichnung	Designation Désignation
VD-2	75 6018	Videoplatine	P.C.B.
D1651	73 1459	 1SS133-T-77	
D1652	73 1459	1SS133-T-77	
D1653	73 1459	1SS133-T-77	
D1654	73 1459	1SS133-T-77	
D1655	73 1459	1SS133-T-77	
IC166	73 6945	 NJM2235L	
IC168	73 1107	LA7016	
B1651	73 2424	 2SC3399-AC	
Q1651	72 1470	2SA608-F-SPA-AC	
Q1653	72 1470	2SA608-F-SPA-AC	
Q1655	72 1470	2SA608-F-SPA-AC	
Q1654	72 8315	2SC536-F-SPA-AC	

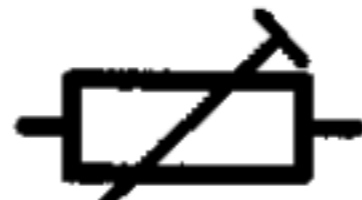

Pos. Item Pos.	Ident-Nr. Ident-No N° d'ident	Bezeichnung	Designation Désignation
VP-1	75 6019	VIDEO (VORVERSTÄRKER)	VIDEO PRE-AMP P.C.B.
IC181 IC291	73 5315 73 7191	 LA7320 BA7740FS	
B1801 Q1801	73 2424 73 2436	 2SC3399AC 2SC2839-F (2SC2669-Y) (2SC2058S)	
Q1802	73 2436	2SC2839-F (2SC2669-Y) (2SC2058S)	
Q1803	73 2436	2SC2839F (2SC2669-Y) (2SC2058S)	
Q1805	72 8435	2SC536F	
VR181 VR182	73 1447 73 1447	 1 KOhm (SEMI) 1 KOhm (SEMI)	





Pos. Item Pos.	Ident-Nr. Ident-No N° d'ident	Bezeichnung	Designation Désignation
AD-1	75 6022	Audioplatine	P.C.B.
D2351	73 1459	 1SS133-T-77	
D2361	73 1459	1SS133-T-77	
D2362	73 1459	1SS133-T-77	
D2363	73 1459	1SS133-T-77	
D2364	73 1459	1SS133-T-77	
IC231	73 7190	 BA7767AS	
B2301	73 4972	 DTC343T-SP	
B2351	73 1476	2SC3402-AC	
B2361	73 2424	2S3399-AC	
Q2331	72 2335	2SD734-F-AA	
Q2361	72 8435	2SC536-F-NP-AA	
Q2363	72 8435	2SC536-F-NP-AA	
Q2364	72 8435	2SC536-F-NP-AA	
Q2362	72 1470	2SA608-F-SPA-AC	
RY231	73 5875	 Relay, 1-2	
T2301	73 4565	 Trans,OSC. 70 KHz	
VR231	73 2643	 150 KOhm or 200 KOhm	
VR232	73 4564	10 KOhm	

SIEMENS

FM626K4
FM626Q4
FM626W4
FM626N4

VIDEOGERÄTE
VIDEO-CASS-RECORDER
Video Equipments
Video Cartride Recorder
Equipments Video
Enregistreur Cassette Video

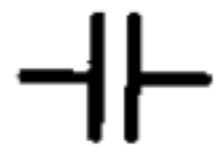
Pos. Item Pos.	Ident-Nr. Ident-No N° d'ident	Bezeichnung	Designation Désignation
PW-1	75 6023	NETZTEIL	POWER SUPPLY P.C.B.
			
D5001	73 4591	LB156-LF-A	
D5002	73 5645	AP01C-V0	
D5003	73 5310	1SS244-T-77	
D5004	73 5310	1SS244-T-77	
D5101	73 7142	RL2Z-LF-B2	
D5102	73 7142	RL2Z-LF-B2	
D5103	73 5646	FML-G12S	
D5104	73 5647	AG01-V2	
D5105	73 5310	1SS244-T-77	
D5107	73 5647	AG01-V2	
D5108	73 4586	MTZ5.6C-T-77	
D5109	73 1459	GMA01-BT	
			
IC501	73 5648	STK73605	
			
Q5101	73 1478	2SD1666-R (2SD1666-S)	



Pos. Item Pos.	Ident-Nr. Ident-No N° d'ident	Bezeichnung	Designation Désignation
T5001	75 5470	 Netztrafo	
L5001 L5002	73 6434 73 7143	 LF Choke LF Choke	
C5001 C5002 C5003 C5021 C5022 C5024 C5025	73 6435 73 6924 73 6999 73 6437 73 6437 73 6438 73 6438	 MT-Polypro 0.22 U F 250V MT-Polypro 0.047U F 250V 82µF 400V Ceramic 1000P F 400V Ceramic 1000P F 400V Ceramic 2200P F 400V Ceramic 2200P F 400V	
R5001 R5101 R5106 R5111	73 5649 73 5719 73 4583 73 4381	 2.7 MOhm 1/2W 2.7 Ohm 1/4W 3.9 Ohm 47 Ohm	
F5001	70 4628	 2.0A/250V	

Pos. Item Pos.	Ident-Nr. Ident-No N° d'ident	Bezeichnung	Designation Désignation
			
B1001	73 2424	2SC3399-AC (DTC144ES-DCTP)	
B1003	73 2424	2SC3399-AC (DTC144ES-DCTP)	
B1091	73 4574	DTC144EL-TL2	
B1202	73 4279	DTC144EL-TL2	
B1204	73 2424	2SC3399-AC (DTC144ES-DCTP)	
Q1001	72 1470	2SA608-E-SPA-AC (2SA933S-TP-Q)	
Q1002	72 2408	2SC536-E-SPA-AC (2SC1740S-DCTP-Q)	
Q1003	72 2408	2SC536-E-SPA-AC	
Q1004	72 2408	1SC1740S-DCTP-Q	
Q1005	72 1470	2SA608-E-SPA-AC (2SA933S-TP-Q)	
Q1007	72 1470	2SA608-E-SPA-AC (2SA933S-TP-Q)	
Q1006	72 2408	2SC536-E-SPA-AC (2SC1740S-DCTP-Q)	
Q1101	72 1470	2SA608-E-SPA-AC (2SA933S-TP-Q)	
Q1102	72 1470	2SA608-E-SPA-AC (2SA933S-TP-Q)	
Q1103	72 2408	2SC536-E-SPA-AC (2SC1740S-DCTP-Q)	
Q1104	72 2408	2SC536-E-SPA-AC (2SC1740S-DCTP-Q)	
Q1105	72 2408	2SC536-E-SPA-AC (2SC1740S-DCTP-Q)	
Q1106	72 2408	2SC536-E-SPA-AC (2SC1740S-DCTP-Q)	
Q1107	72 1470	2SA608-E-SPA-AC	
Q1201	72 2408	2SC536-E-SPA-AC (2SC1740S-DCTP-Q)	
Q1401	72 8058	2SA984-E-AA (2SA984-F-AA)	
Q1402	73 6947	2SA1561	
Q1403	72 1470	2SA608-E-SPA-AC (2SA933-S-TP-Q)	
Q1404	73 2443	2SB985-T-AE	
Q1405	72 2408	2SC536-E-SPA-AC (2SC1740S-DCTP-Q)	
Q1406	72 2408	2SC536-E-SPA-AC (2SC1740S-DCTP-Q)	

SIEMENS

FM626K4
FM626Q4
FM626W4
FM626N4





VIDEOGERÄTE
VIDEO-CASS-RECORDER
Video Equipments
Video Cartride Recorder
Equipments Video
Enregistreur Cassette Video



Pos. Item Pos.	Ident-Nr. Ident-No N° d'ident	Bezeichnung	Designation Désignation
PW-2	75 6024	NETZTEIL	POWER SUPPLY P.C.B.
D5201	73 5310	 1SS244-T-77	
IC521	73 5275	 STK5473	

SIEMENS

FM626K4
FM626Q4
FM626W4
FM626N4

VIDEOGERÄTE
VIDEO-CASS-RECORDER
Video Equipments
Video Cartridge Recorder
Equipments Video
Enregistreur Cassette Video

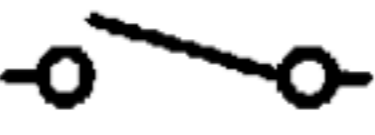



Pos. Item Pos.	Ident-Nr. Ident-No N° d'ident	Bezeichnung	Designation Désignation
MPX	75 6276	Decoder (MPX)	P.C.B.
D6301	73 4004	 DSB015-TB	
IC631	73 4988	 TDA3803A	
B6301	73 4290	 2SC3395-TB	
B6302	73 4281	2SC3396-TB	
B6303	73 4597	2SC3398-TB	
B6304	73 4290	2SC3395-TB	
B6305	73 4290	2SC3395-TB	
Q6301	73 5416	2SC2812-L6-TB	
Q6302	73 5416	2SC2812-L6-TB	
Q6303	73 5416	2SC2812-L6-TB	
VR631	73 4377	 15 KOhm	
VR632	73 3131	2 KOhm	
VR633	73 3993	500 Ohm	





Pos. Item Pos.	Ident-Nr. Ident-No N° d'ident	Bezeichnung	Designation Désignation
TM-1	75 6014	BEDIENTEIL	TIMER MODUL/SOUS-TEMPS
A7101	75 5978	Anzeige (VFD)	indication
RR711	73 6567	IR-Empfänger	receiver/recepteur
S7101	73 1497		
S7102	73 1497		
S7106	73 1497		
S7107	73 1497		
S7108	73 1497		
S7113	73 1497		
S7114	73 1497		
S7118	73 1497		
S7120	73 1497		
S7125	73 1497		
S7126	73 1497		
S7129	73 1497		
S7130	73 1497		
S7137	73 1497		
D7101	73 1459	 1SS133-T-77 (GMA01-BT)	
D7102	73 1459		
D7103	73 1459		
D7104	73 1459		
D7105	73 1459		
D7106	73 1459		
D7107	73 1459		
D7108	73 1459		
D7109	73 1459		
D7110	73 1459		
D7111	73 1459		
D7112	73 1459		
D7113	73 1459		



SIEMENS





FM626K4
FM626Q4
FM626W4
FM626N4





VIDEOGERÄTE
VIDEO-CASS-RECORDER
Video Equipments
Video Cartride Recorder
Equipments Video
Enregistreur Cassette Video

Pos. Item Pos.	Ident-Nr. Ident-No N° d'ident	Bezeichnung	Designation Désignation
			
D7114	73 1459	1SS133-T-77 (GMA01-BT)	
D7115	73 1459	1SS133-T-77 (GMA01-BT)	
D7116	73 1459	1SS133-T-77 (GMA01-BT)	
D7117	73 1459	1SS133-T-77 (GMA01-BT)	
D7118	73 1459	1SS133-T-77 (GMA01-BT)	
D7119	73 1459	1SS133-T-77 (GMA01-BT)	
D7120	73 1459	1SS133-T-77 (GMA01-BT)	
D7121	73 1459	1SS133-T-77 (GMA01-BT)	
D7122	73 1459	1SS133-T-77 (GMA01-BT)	
D7123	73 1459	1SS133-T-77 (GMA01-BT)	
D7124	73 1459	1SS133-T-77 (GMA01-BT)	
D7125	73 1459	1SS133-T-77 (GMA01-BT)	
D7152	73 1459	1SS133-T-77 (GMA01-BT)	
D7153	73 1459	1SS133-T-77 (GMA01-BT)	
			
IC711	73 6929	M50959-194SP	
IC712	73 2704	MN1280-L (MN1380-L)	
IC713	73 5318	M6M80021P	
			
B7151	73 4279	DTC144EL-T2	
B7152	73 4279	DTC144EL-T2	
			
RB711	73 0818	10 KOhm x 6 Pack	
			
X7101	73 5326	6.391456 MHz	
X7102	73 2454	32.768 KHz	

Pos. Item Pos.	Ident-Nr. Ident-No N° d'ident	Bezeichnung	Designation Désignation
TM-2	75 6020	Timerplatine FM626Q4/W4	Timer P.C.B.
TM-2	75 6313	Timerplatine FM626K4/N4	Timer P.C.B.
D7251	73 7209	 GZS4.7Z-BT	
B7251	73 4279	 DTC144EL-TL2	
B7252	73 4279	DTC144EL-TL2	
Q7251	73 6947	2SA1561TL2	
S7251	73 7054	 SLIDE 1-2	
S7276	73 7353	SLIDE 2-2	
VR751	73 7210	 5 KOhm (Rotary)	
TM-3	75 6021	Timerplatine	Timer P.C.B.
CN795	75 6021	Buchse Mic.	Jack Mic
TN-5	75 6314	Nicam III (FZ150G4/FM626N4)	Nicam P.C.B.

Pos. Item Pos.	Ident-Nr. Ident-No N° d'ident	Bezeichnung	Designation Désignation
TM-6	75 6030	Videotext (VPT) 	P.C.B.
D7601	73 4003	DSK10C-BT	
D7602	73 4003	DSK10C-BT	
D7603	72 7916	DCB015-TB (DAN202K-T-96)	
D7651	72 7916	DCB015-TB (DAN202K-T-96)	
D7652	72 7916	DCB015-TB (DAN202K-T-96)	
D7653	72 7916	DCB015-TB (DAN202K-T-96)	
D7654	72 7916	DCB015-TB (DAN202K-T-96)	
D7655	72 7916	DCB015-TB (DAN202K-T-96)	
D7656	72 7916	DCB015-TB (DAN202K-T-96)	
D7657	72 7916	DCB015-TB (DAN202K-T-96)	
D7658	72 7916	DCB015-TB (DAN202K-T-96)	
D7659	72 7916	DCB015-TB (DAN202K-T-96)	
D7660	73 7019	ZENER MTZJ4.3A-T-77 	
IC761	73 6950	8031AH	
IC762	73 7211	MBM27C512P-20P-100	
IC763	73 6952	LH5164-12	
IC764	73 6953	TC74HC373P	
IC765	73 4568	MN1280-R	
IC766	73 6954	SDA5231	
IC767	73 6955	SDA5243	
IC768	73 6953	LH5164-12	
IC769	73 6956	MC1377	
IC770	73 6386	NJM2235D	

Pos. Item Pos.	Ident-Nr. Ident-No N° d'ident	Bezeichnung	Designation Désignation
			
B7602	73 4597	2SC3398-TB	
B7603	73 5779	2SA1344-TB	
Q7601	73 5416	2SC2812-L6-TB	
Q7602	73 5416	2SC2812-L5-TB (2SC2812-L6-TB)	
Q7651	73 5415	2SA1179-M5-TB (2SA1179-M6-TB)	
Q7553	73 5416	2SC2812-L5-TB (2SC2812-L6-TB)	
Q7654	73 5415	2SA1179-M5-TB (2SA1179-M6-TB)	
Q7655	73 5415	2SA1179-M5-TB (2SA1179-M6-TB)	
Q7656	73 5415	2SA1179-M5-TB (2SA1179-M6-TB)	
Q7657	73 5416	2SC2812-L5-TB (2SC2812-L6-TB)	
Q7658	73 5415	2SA1179-M5-TB (2SA1179-M6-TB)	
Q7659	73 5415	2SA1179-M5-TB (2SA1179-M6-TB)	
Q7660	73 5416	2SC2812-L5-TB (2SC2812-L6-TB)	
Q7661	73 5416	2SC2812-L5-TB (2SC2812-L6-TB)	
			
X7601	73 6957	RESONATOR,CERAMIC 12 MHz	
X7651	73 3632	13.875MHz	
X7652	73 3631	6MHz	
X7653	73 3997	4.433619MHz	
		 	
XF761	73 7021	Filter 4,43 MHz	
XF762	73 7022	Filter 3 MHz	
CT761	73 2451	Trimmer	

Pos. Item Pos.	Ident-Nr. Ident-No N° d'ident	Bezeichnung	Designation Désignation
TM-7	75 6260	Timerplatine	Timer P.C.B.
			
IC778	73 0128	LA7210	
			
B7751	73 4290	2SC3395-TB (DTC144EK-T96)	
TB-1	75 6016	Buchsenplatte	Terminal PCB.
			
D8501	73 4586	MTZJ5.6B-T-77	
D8502	73 4586	MTZJ5.6B-T-77	
D8503	73 4586	MTZJ5.6B-T-77	
D8504	73 4586	MTZJ5.6B-T-77	
			
IC851	73 4431	TK15021	
			
VR851	73 6640	100 KOhm Rotary	
VR852	73 6640	100 KOhm Rotary	

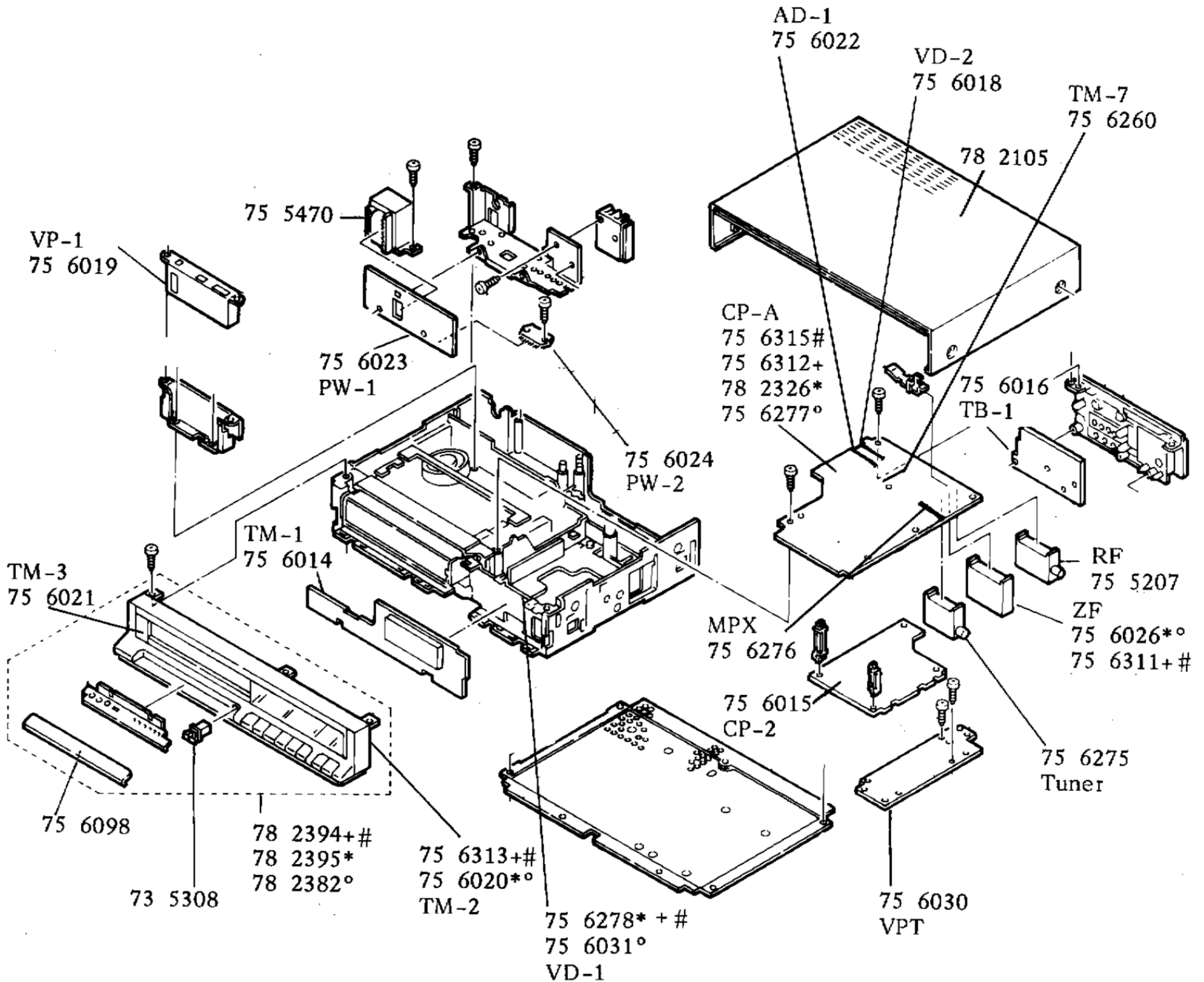

FM626N4
+ FM626K4/N4
* FM626Q4
° FM626W4

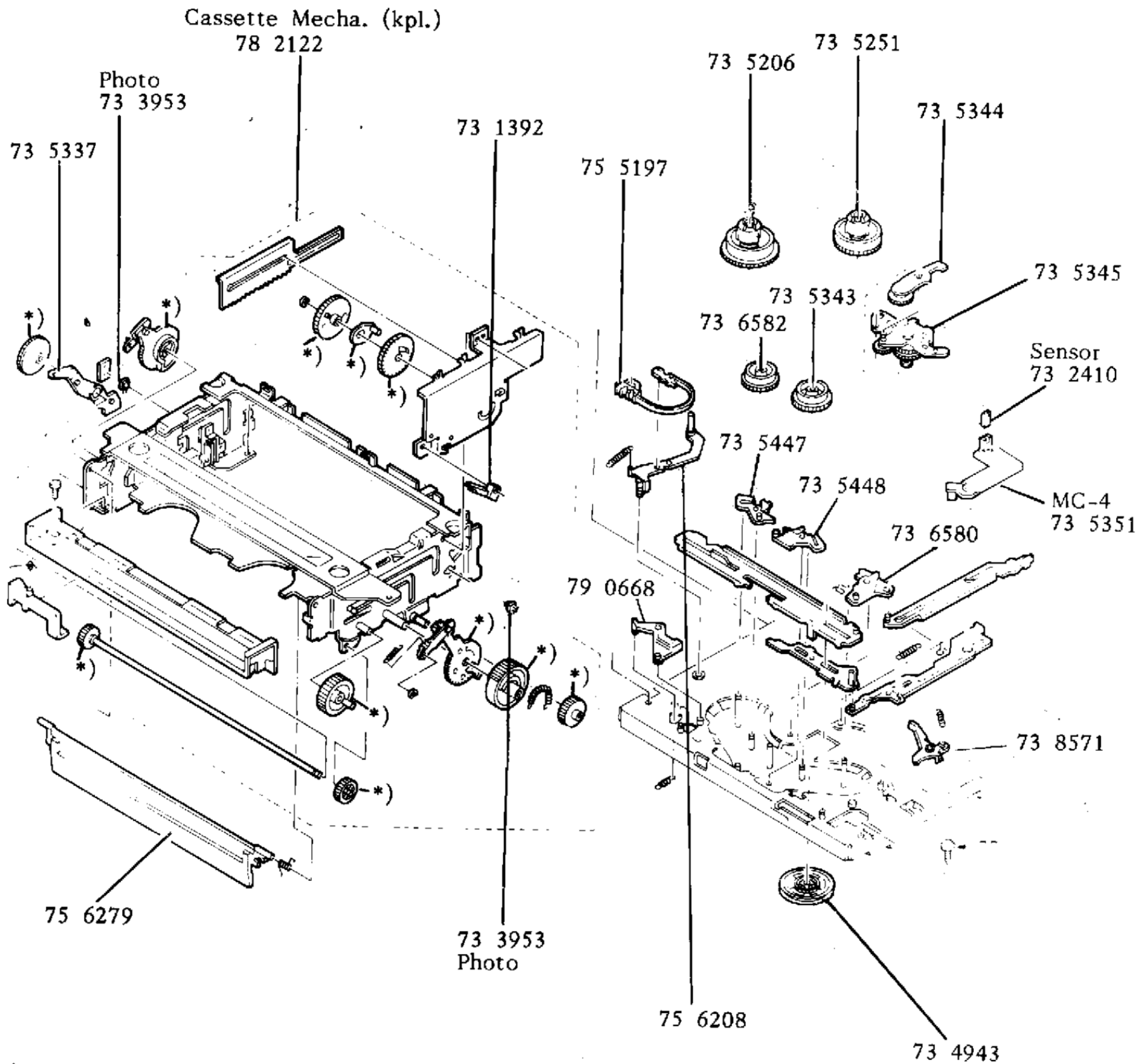

* Rep.-Satz
Rep.-set
73 5336



Federsatz kpl.
Spring-set
73 5335

Sicherungsringe
Washer-set
73 6570

SIEMENS

FM626K4
FM626Q4
FM626W4
FM626N4

VIDEOGERÄTE
VIDEO-CASS-RECORDER
Video Equipments
Video Cartride Recorder
Equipments Video
Enregistreur Cassette Video

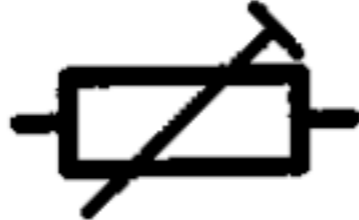
Pos. Item Pos.	Ident-Nr. Ident-No N° d'ident	Bezeichnung	Designation Désignation
DL111	73 5651	 Delay 2H	
X1101	73 7817	 4.433619 MHz	
VR101	73 3994	 20 KOhm	
VR102	73 2933	10 KOhm	
VR104	73 2933	10 KOhm	
VR103	73 1447	1 KOhm	
VR111	73 1447	1 KOhm	
VR191	73 1460	220 KOhm	

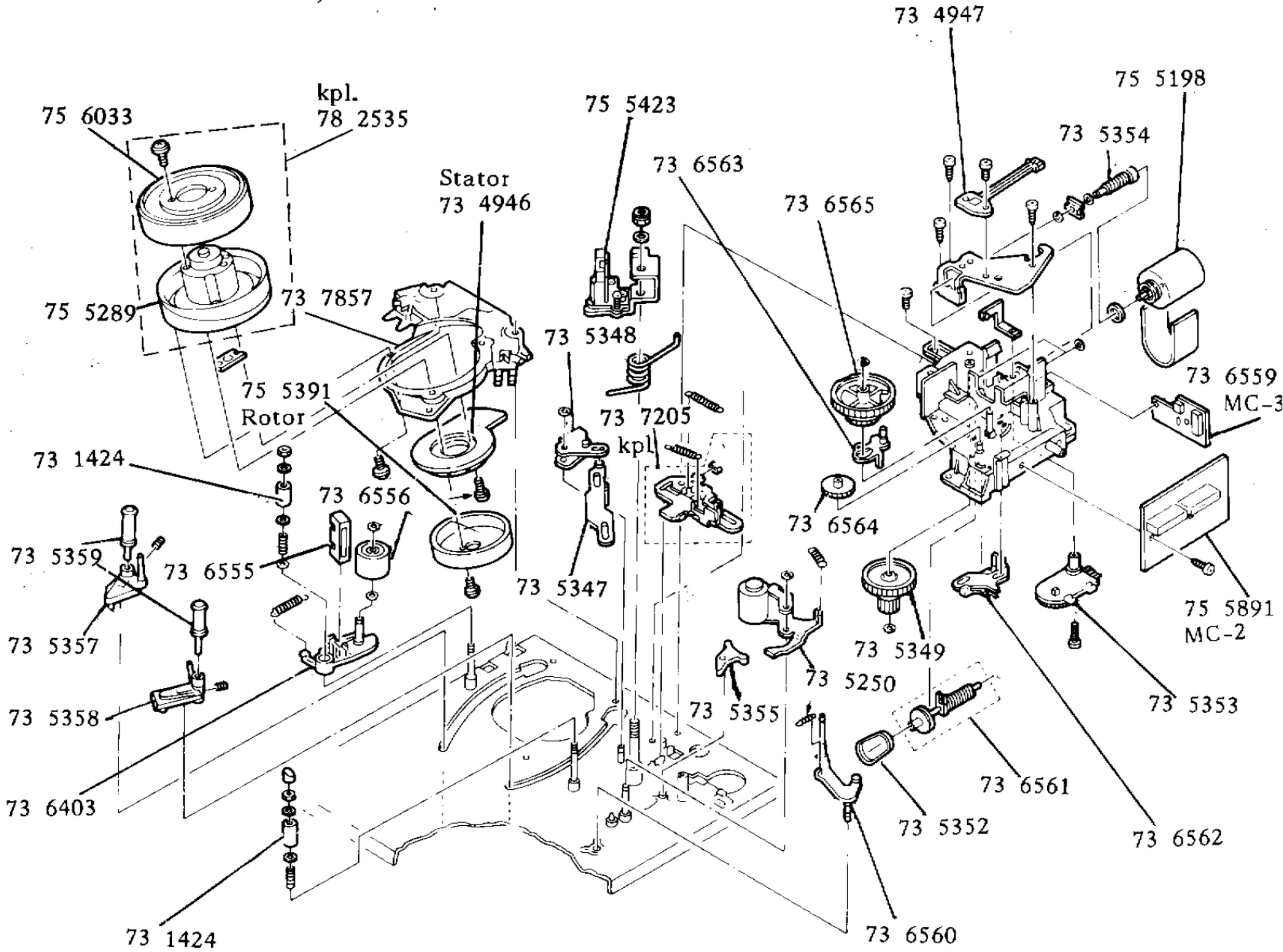

Federsatz kpl.
Spring-set
73 5335

Sicherungsringe
Washer-set
73 6570

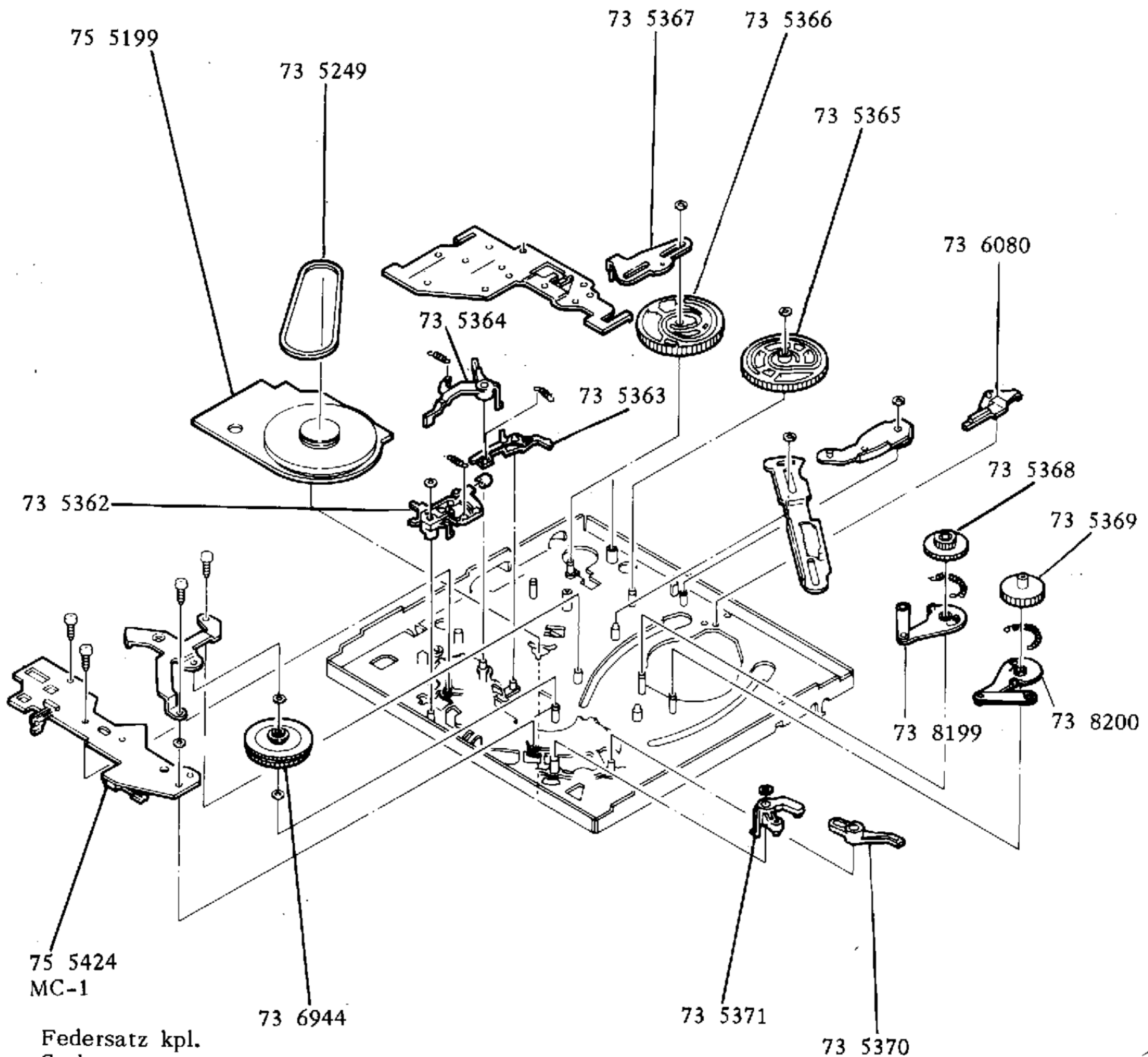

Federsatz kpl.
Spring-set
73 5335

Sicherungsringe
Washer-set
73 6570

FM626K4
FM626Q4
FM626W4
FM626N4



VIDEOGERÄTE
VIDEO-CASS-RECORDER
Video Equipments
Video Cartride Recorder
Equipments Video
Enregistreur Cassette Video

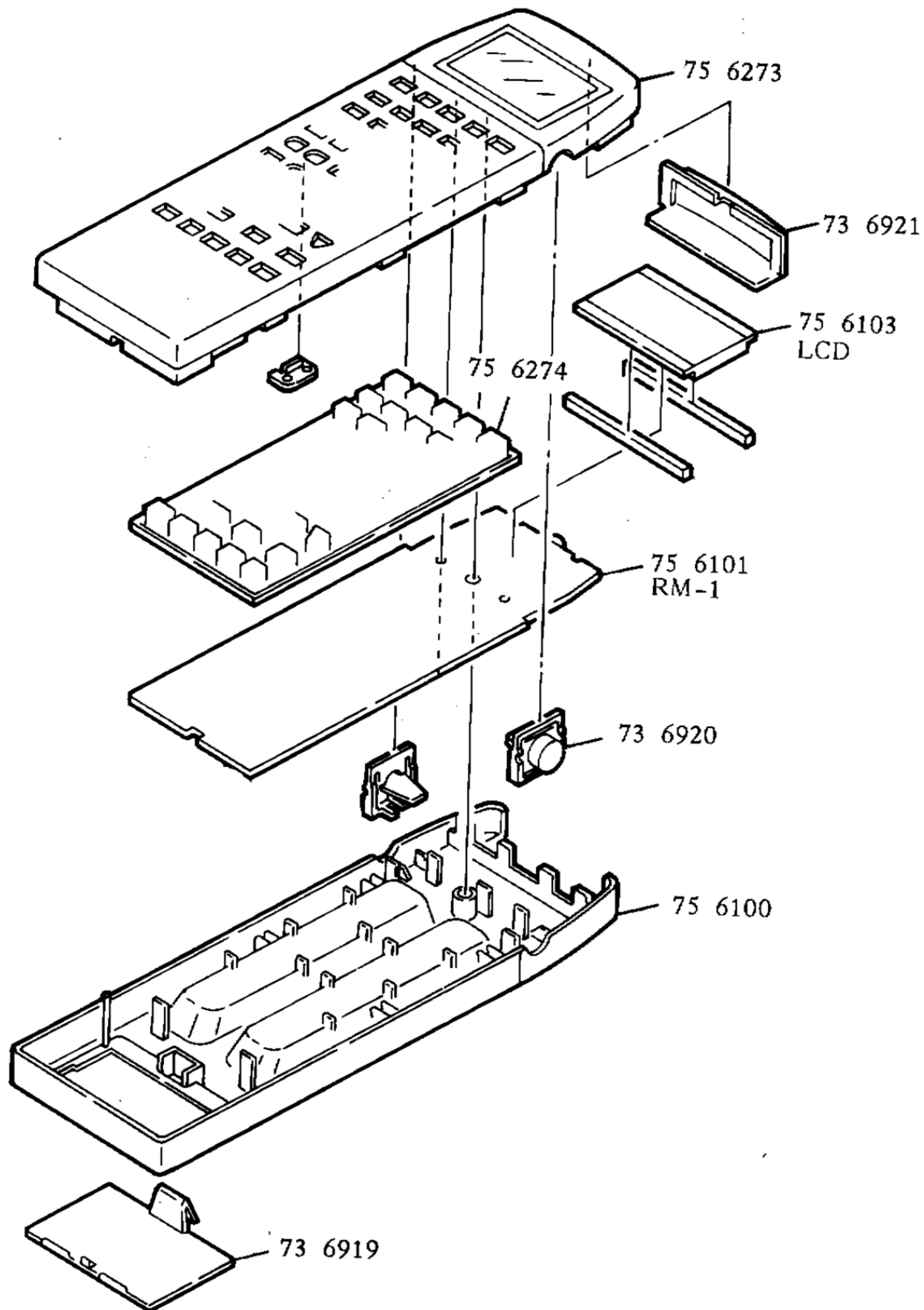

75 6027
Fernbedienung kpl.
Remote control cpl.
Telecommande cpl.











Pos. Item Pos.	Ident-Nr. Ident-No N° d'ident	Bezeichnung	Designation Désignation
	53 0598	Gebrauchsanweisung Videotext FZ130G4	instruction manual (VT)
	53 0680	Gebrauchsanweisung (6-sprachig) (FM626Q4/K4/W4/N4)	instruction manual
	53 0565	Gebrauchsanweisung (deutsch) (FM626Q4/K4/W4) Service-Druckschrift	instruction manual service-booklet brochure service
	53 5338 53 5340	Schaltplan (FM626Q4/ W4) Schaltplan (FM626K4/N4)	circuit diagram schéma de commutation
		Abgleich	alignment alignement
	53 5337	Elektrisch	
	53 5282	Mechanisch Teil II	
	53 5342	Nicam III (FZ150G4/FM626N4)	Nicam III
		Service Mittel	service tools
	34 0114	Drehmomentmesser	torgue gauge
	34 0119	Höhenmeßuhr	hight gauge
	34 0105	Cassettenlehre	tape gauge
	34 0101	Exentrik/ 3 mm	exentrik/ 3 mm
	34 0125	Einstellehre	pos. adj.
	34 0115	Drehmomentschlüssel	screw adj.
	34 0130	Höheneinsteller	hight gauge adj.
	34 0131	Mode Selection	mode selection
	34 0142	Adapter Mode Selc.	adapter
	34 0222	Adapterkabel 26 P	adapter cable
	75 5519	Adapterkabel DM-4	adaper cable
	34 0162	Testcassette FM Audio	test tape FM-Audio
	34 0163	Multi Testcassette	multi tape
	34 0164	Testcassette PAL/LP	test tape PAL/LP
	34 0165	Testcassette DOC	test tape DOC
	34 0141	Testcassette S-VHS	test tape S-VHS
	34 0156	Bandzugcassette 60/ 300g	tension tape
	34 0219	Bandzugcassette 800 g	tension tape



Pos. Item Pos.	Ident-Nr. Ident-No N° d'ident	Bezeichnung	Designation Désignation
AD-A	—	Audio (CP-A)	
			
D2201	73 1459	1SS133-T-77 (GMA01-BT)	
D2202	73 1459	GMA01-BT (1SS133-T-77)	
D2203	73 1459	1SS133-T-77 (GMA01-BT)	
D2204	73 1459	1SS133-T-77 (GMA01-BT)	
D2205	73 1459	1SS133-T-77 (GMA01-BT)	
D2207	73 1459	1SS133-T-77 (GMA01-BT)	
D2210	73 1459	GMA01-BT (1SS133-T-77)	
D2215	73 1459	1SS133-T-77 (GMA01-BT)	
D2216	73 1459	1SS133-T-77 (GMA01-BT)	
D2217	73 1459	1SS133-T-77 (GMA01-BT)	
D2218	73 1459	1SS133-T-77 (GMA01-BT)	
D2219	73 1459	1SS133-T-77 (GMA01-BT)	
D2220	73 1459	1SS133-T-77 (GMA01-BT)	
D2222	73 1459	1SS133-T-77 (GMA01-BT)	
D2223	73 1459	1SS133-T-77 (GMA01-BT)	
D2224	73 1459	1SS133-T-77 (GMA01-BT)	
D2225	73 1459	1SS133-T-77 (GMA01-BT)	
D2226	73 1459	1SS133-T-77 (GMA01-BT)	
D2227	73 1459	1SS133-T-77 (GMA01-BT)	
D2228	73 1459	1SS133-T-77 (GMA01-BT)	
D2229	73 1459	1SS133-T-77 (GMA01-BT)	

Pos. Item Pos.	Ident-Nr. Ident-No N° d'ident	Bezeichnung	Designation Désignation
D2230	73 1459	 1SS133-T-77 (GMA01-BT)	
D2231	73 1459	1SS133-T-77	
D2237	73 1459	1SS133-T-77 (GMA01-BT)	
D2238	73 4586	Zener MTZ5.6C-T-77	
D2239	73 1459	1SS133-T-77 (GMA01-BT)	
IC201	73 7187	 BX7709W	
IC202	73 7206	TA8694AN	
IC204	73 5879	M5236L	
IC205	73 5882	M5278L05-01	
IC206	73 7207	M5278L56-TC04A-31	
IC221	73 7189	M5201L	
IC222	73 7188	M5207L01	
B2001	73 4972	 DTC343T-STP	
B2101	73 4972	DTC343T-STP	
B2201	73 4279	DTC144EL-TL2	
B2208	73 4279	DTC144EL-TL2	
B2209	73 4279	DTC144EL-TL2	
B2210	73 1852	2SA1346-AC	
B2211	73 2424	2SC3399-AC (DTC144ES-DCTP)	
B2212	73 1852	2SA1346-AC	
B2213	73 2424	2SC3399-AC (DTC144ES-DCTP)	
B2214	73 1852	2SA1346-AC	
B2215	73 2424	2SC3399-AC (DTC144ES-DCTP)	
B2216	73 2424	2SC3399-AC (DTC144-ES-DCTP)	
B2217	73 4279	DTC144-EL-TL2	
B2219	73 4279	DTC144EL-TL2	
B2220	73 2424	2SC3399-AC	
B2223	73 4279	DTC144EL-TL2	
B2224	73 4279	DTC144EL-TL2	
B2225	73 4279	DTC144EL-TL2	
B2226	73 4574	DTA144EL-TL2	
B2228	73 4279	DTC144EL-TL2	

Pos. Item Pos.	Ident-Nr. Ident-No N° d'ident	Bezeichnung	Designation Désignation
B2230	73 4279	 DTC144EL-TL2	
B2231	73 4574	DTA144EL-TL2	
B2232	73 4279	DTC144EL-TL2	
B2233	73 4574	DTA144EL-TL2	
B2237	73 2424	2SC3399-AC	
B2238	73 2424	2SC3399-AC	
Q2001	72 8435	2SC536-E-NPAA	
Q2101	72 8435	2SC536-E-NPAA	
Q2201	72 0886	2SB544-F	
Q2202	73 1458	2SC3070-AE	
Q2203	73 4572	2SC4038-Q-TL2	
Q2251, Q2252	72 1470 72 1470	2SA608-F 2SA608-F	
PR221	75 3703	 Schutzschaltung (400MA150V)	circuit protector

Pos. Item Pos.	Ident-Nr. Ident-No N° d'ident	Bezeichnung	Designation Désignation
PW-A	-	NETZTEIL (CP-A)	POWER SUPPLY (CP-A)
			
D5401	73 1459	GMA01-BT (1SS133-T-77)	
D5402	72 8471	Zener MTZ5.1B	
D5403	73 0473	Zener MTZ6.8C	
D5404	73 5310	1SS244-T-77	
D5405	73 4590	Zener MTZ33A	
D5406	73 4592	Zener MTZ10C	
D5407	73 1459	1SS133-T-77	
			
Q5401	73 6566	2SA1703	
Q5402	73 4001	2SC3807	
Q5403,	72 8058	2SA984	
Q5404	72 8058	2SA984	
			
R5404	73 4890	820 Ohm 1/4W	
R5408	72 9424	47 Ohm 1/4 W	

Pos. Item Pos.	Ident-Nr. Ident-No N° d'ident	Bezeichnung	Designation Désignation
TN-A	-	TUNERPLATINE (CP-A) TUNER 	P.C.B.
D6001	73 1459	1SS133-T-77	
D6002	73 1459	1SS133-T-77	
D6003	73 1459	1SS133-T-77	
D6004	73 1459	1SS133-T-77	
D6005	73 1459	1SS133-T-77	
D6006	73 1459	1SS133-T-77	
D6007	73 1459	1SS133-T-77	
Q6002	72 1470	 2SA608F	
TM-A	-	TIMERPLATINE (CP-A) 	TIMER P.C.B.
D7001	73 1459	1SS133	
IC701	73 1589	 L5631	
IC703	73 3664	LA7214	
IC704	73 5313	SDA5642	
B7001	73 1476	 2SC3402	
B7002	73 4574	DTA144EL-TL2	
Q7001	73 2443	2SB985	
CV-A	-	RF (MODULATOR) PLATINE (CP-A)	RF CONVERTER P.C.B.
D6601	73 4003	DSK10C (ERA15-02A)	

Pos. Item Pos.	Ident-Nr. Ident-No N° d'ident	Bezeichnung	Designation Désignation
CP-2 SY-B	75 6015 -	Chassis System Control (CP-2)	P.C.B. P.C.B.
			
D3001	73 5310	1SS244-T-77	
D3005	73 1459	1SS133-T-77 (GMA01-BT)	
D3006	73 1459	1SS133-T-77 (GMA01-BT)	
D3007	73 1459	1SS133-T-77 (GMA01-BT)	
D3011	73 1459	1SS133-T-77 (GMA01-BT)	
D3201	73 0593	Zener GZS8.2Y-BT (Zener MTZJ8.2B-T-77)	
D3202	73 7208	Zener GZS5.6Y-BT (Zener MTZJ5.6B-T77)	
D3203	73 1459	1SS133-T-77 (GMA01-BT)	
D3204	73 1459	1SS133-T-77 (GMA01-BT)	
D3301	73 7208	Zener MTZ5.6B	
D3302	73 1459	1SS133-T-77	
D3303	73 1459	1SS133-T-77	
			
IC301	73 7051	UPD75516GF-055-3B9 (UPD755166F-075-3B9)	
IC302	73 3656	LB1641	
IC303	72 7924	LA6393S	
IC304	73 4568	MN1280-R/S (MN1380-R/S)	