









Pos. Item Pos.	Ident-Nr. Ident-No N°d'ident	Bezeichnung	Designation Désignation
		Alle mit * gekennzeichneten Teile sind in der Version "A" enthalten.	All parts signed with * are used in "A"-version .
		Druckschriften	
	53 1038	Gebrauchsanweisung	instruction manual
	53 1082	Gebrauchsanweisung *	mode d'emploi
	53 5570	Service Manual	
		Zubehör	
	75 8601	Skart Kabel, 21 Pin	scart cable, 21 pin
	75 9094	Fernbedienung	remote control
	75 9140	Fernbedienung *	
		Funktionseinheiten	
TU401	75 9102	Tuner	TSU2-E51P
MD401	75 8717	Modulator	MCB8-UG3639
	75 9103	Display	P.C.B
		Diverse Teile	
	79 2926	Euro AV-Buchse	skart jack
	75 8509	Netzkabel	power cord
	79 4816	IR-Empfänger	IR-receiver
			
	79 4507	LED-Anzeige, grün	display, green
D101	79 4506	LED, rot-grün	red-green
D102	79 2907	LED, rot	red, 5mm
D103	79 2907	LED, rot	red, 5mm
D104	79 2905	LED, grün	green, 5mm
D106	79 4506	LED, rot-grün	red-green
D107	70 6829	1N4148	
D108	70 6829	1N4148	
D109	79 4506	LED, rot-grün	red-green
D110	79 2905	LED, grün	green, 5mm
D111	79 4506	LED, rot-grün	red-green
D301	70 9579	1N4002	
D302	70 9579	1N4002	

Pos. Item Pos.	Ident-Nr. Ident-No N°d'ident	Bezeichnung	Designation Désignation
			
D303	70 9579	1N4002	
D304	70 9579	1N4002	
D305	70 9579	1N4002	
D306	70 9579	1N4002	
D307	70 6829	1N4148	
D402	70 6829	1N4148	
D403	70 6829	1N4148	
D404	70 6829	1N4148	
D405	70 6829	1N4148	
D406	70 6829	1N4148	
D407	70 6829	1N4148	
D408	70 6829	1N4148	
D409	70 6829	1N4148	
D410	70 6829	1N4148	
D412	70 6829	1N4148	
D413	70 6829	1N4148	
D414	70 6829	1N4148	
D415	70 6829	1N4148	
D416	70 6829	1N4148	
D417	70 6829	1N4148	
D418	70 6829	1N4148	
D501	79 2903	1SV68	
D504	70 6829	1N4148	
D505	70 6829	1N4148	
D506	70 6829	1N4148	
D507	79 4509	1SS85	
D508	79 4509	1SS85	
D509	79 4509	1SS85	
D510	79 4509	1SS85	
D511	70 6829	1N4148	

Pos. Item Pos.	Ident-Nr. Ident-No N°d'ident	Bezeichnung	Designation Désignation
			
Q9	79 2898	2N3904	
Q11	79 2898	2N3904	
Q21	79 2898	2N3904	
Q101	79 2901	5088	
Q102	79 2901	5088	
Q103	79 2901	5088	
Q104	79 2901	5088	
Q105	79 2898	2N3904	
Q106	79 2898	2N3904	
Q107	79 2898	2N3904	
Q108	79 2898	2N3904	
Q109	79 2898	2N3904	
Q110	79 2898	2N3904	
Q301	79 2898	2N3904	
Q302	79 2898	2N3904	
Q303	79 2898	2N3904	
Q304	79 2898	2N3904	
Q305	79 2898	2N3904	
Q306	79 2899	2N3906	
Q401	79 2898	2N3904	
Q402	79 2898	2N3904	
Q403	79 2898	2N3904	
Q404	79 2898	2N3904	
Q405	79 2898	2N3904	
Q406	79 2898	2N3904	
Q407	79 2898	2N3904	
Q409	79 2898	2N3940	
Q410	79 2898	2N3904	
Q411	79 2898	2N3904	
Q412	79 2899	2N3906	
Q414	79 2899	2N3906	
Q415	79 2898	2N3904	
Q501	79 2898	2N3904	
Q502	79 2898	2N3904	
Q504	79 2900	945P	

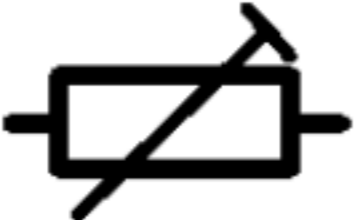
Pos. Item Pos.	Ident-Nr. Ident-No N°d'ident	Bezeichnung	Designation Désignation
		Alle mit * gekennzeichneten Teile sind in der Version "A" enthalten.	All parts signed with * are used in "A"-version.
			
Q505	79 2900	945P	
Q506	79 2898	2N3904	
Q507	79 2898	2N3904	
Q508	79 2900	945P	
Q509	79 2898	2N3904	
Q510	79 2898	2N3904	
Q511	79 2898	2N3904	
Q512	79 2898	2N3904	
			
SW101	79 2871	Druckschalter	Prog +
SW102	79 2871	Druckschalter	Prog -
SW103	79 2871	Druckschalter	Power
SW301	79 4525	Schiebeschalter	LNB Power
SW402	79 3454	Schiebeschalter	Int-Ext
			
U3	79 2892	CD4053BCN	
U101	79 4511	MC4556	
U301	79 2889	7812	
U302	79 2885	7812R	
U303	79 2886	7805	
U304	79 4512	HA17555	
U305	79 2888	LM317	
U401	79 2891	NE592N	
U402	79 4510	LSC404295P (6805U3)	
U402	79 4706	LSC404327 *	
U404	79 2890	CD4066BP	
U405	79 2894	93C66	
U406	79 2894	93C66	
U407	79 2896	LM7001	
U501	79 2895	NE612	
U502	79 2896	LM7001	

Pos. Item Pos.	Ident-Nr. Ident-No N°d'ident	Bezeichnung	Designation Désignation
U503	79 2897	 U2829B-B	
U504	79 4383	CD4052BE	
U505	79 4383	CD4052BE	
VR301	79 4505	 500 Ohm	
VR401	79 4504	2 KOhm	
X501	79 2909	 4 MHz	
X502	79 4508	10.52 MG21	
X503	79 2910	10.7 MG21	
Y401	79 3418	5.625 MHz	
Y402	79 2909	4 MHz	

Alle mit * gekennzeichneten Teile sind in der Version "A" enthalten.
All parts signed with * are used in "A"-version.

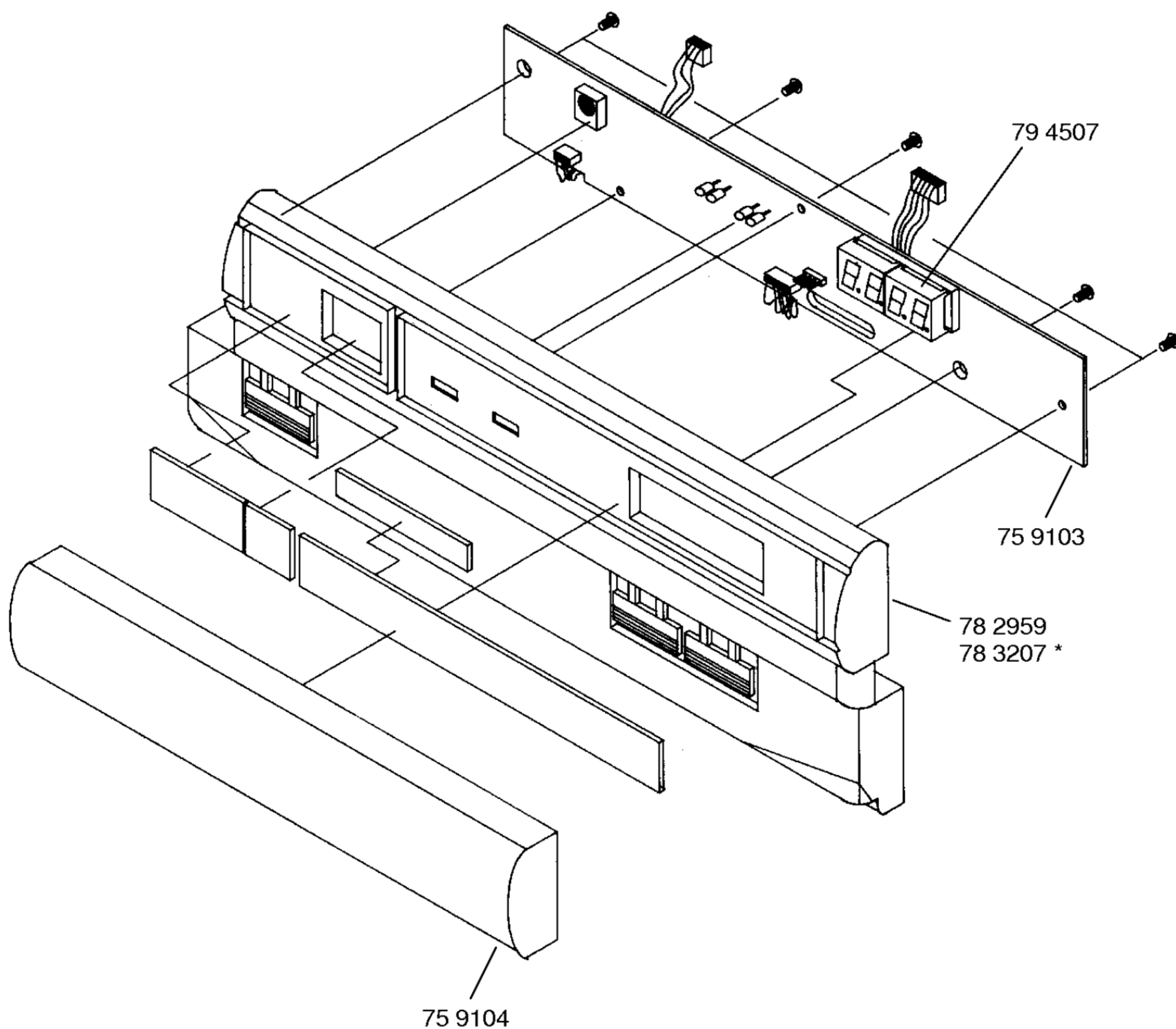

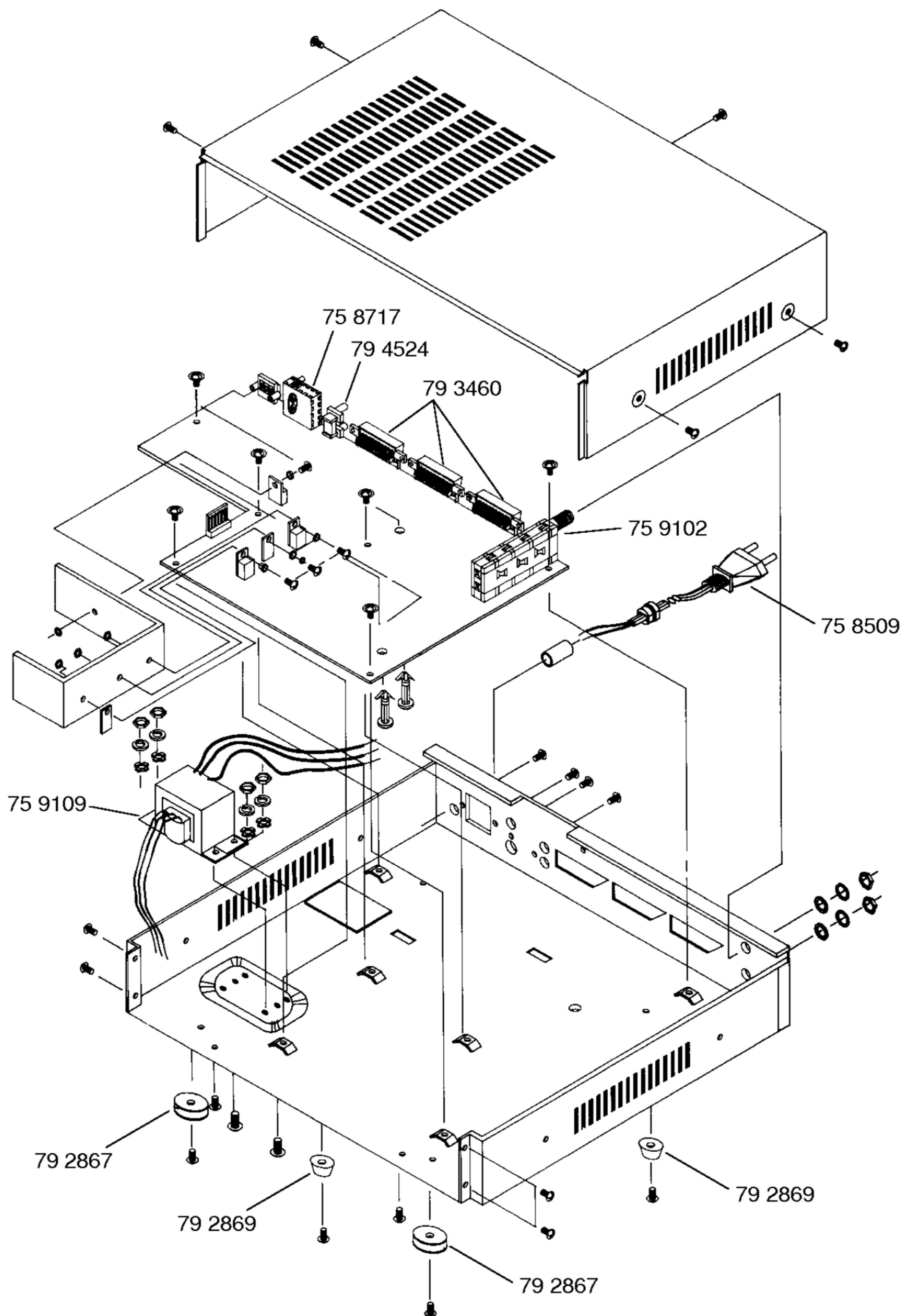

Alle mit * gekennzeichneten Teile sind in der Version "A" enthalten.
All parts signed with * are used in "A"-version.

